

Chapter 30 Induction and Inductance

- A current produces a magnetic field (in Chapter 29).
- A magnetic field can produce an electric field that can drive a current.
- This link between a magnetic field and the electric field it produces (*induces*) is now called *Faraday's law of induction*.

Two Experiments

● 1st Experiment:

1. A current appears only if there is relative motion between the loop and the magnet; the current disappears when the relative motion between them ceases.
2. Faster motion produces a greater current.
3. If moving the magnet's north pole toward the loop causes clockwise current, then moving the north pole away causes counterclockwise current. Moving the south pole toward or away from the loop also causes currents, but in the reversed directions.

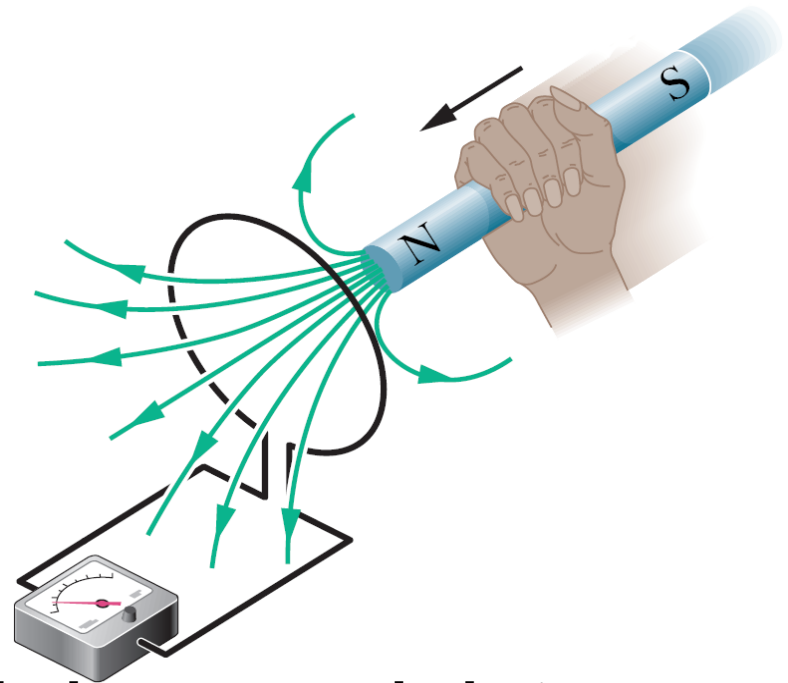

- The current produced in the loop is called an **induced current**; the work done per unit charge to produce that current is called an **induced emf**; and the process of producing the current and emf is called **induction**.

● 2nd Experiment:

1. If we turn on a current in the right-hand loop, the meter suddenly and briefly registers a current an induced current in the left-hand loop.
2. If we then open the switch, another sudden and brief induced current appears in the left-hand loop, but in the opposite direction.
3. We get an induced current (and thus an induced emf) only when the current in the right-hand loop is changing (either turning on or turning off) and not when it is constant (even if it is large).

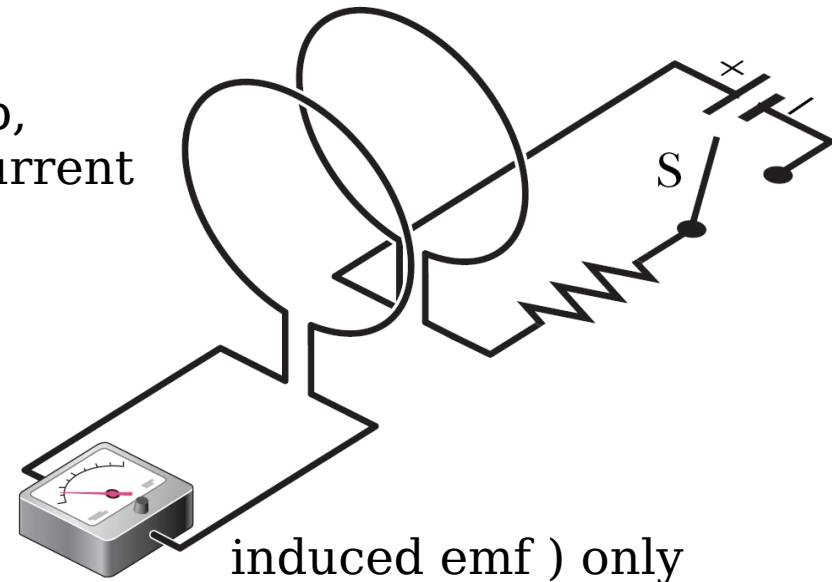

Faraday's Law of Induction

● Faraday's law of induction:

An emf is induced in the loop at the left in the 1st and 2nd experiments when the number of magnetic field lines that pass through the loop is changing.

- The values of the induced emf and induced current are determined by the *rate* at which that number changes.

A Quantitative Treatment

- Suppose a loop enclosing an area A is placed in a magnetic field. Then the **magnetic flux** through the loop is

$$\Phi_B = \int \vec{B} \cdot d\vec{A} \quad \text{magnetic flux through area } A$$

- If the loop lies in a plane and that the magnetic field \perp the plane of the loop,

$$\Phi_B = \int B \cos \theta \, dA = B \int dA = B A \quad \leftarrow \quad \vec{B} \parallel \vec{A}, \vec{B} \text{ uniform}$$

- The SI unit for magnetic flux is the tesla-square meter, or the *weber* (Wb):

$$1 \text{ weber} = 1 \text{ Wb} = 1 \text{ T} \cdot \text{m}^2$$

- With the notion of magnetic flux, we can state Faraday's law as

The magnitude of the emf \mathcal{E} induced in a conducting loop is equal to the rate at which the magnetic flux Φ_B through that loop changes with time.

- Since the induced emf \mathcal{E} tends to oppose the flux change, so Faraday's law is formally written as

$$\mathcal{E} = - \frac{d \Phi_B}{d t} \quad \text{Faraday's law}$$

- If we change the magnetic flux through a coil of N turns, and the coil is tightly wound (*closely packed*), so that the same magnetic flux passes through all the turns, the total emf induced in the coil is

$$\mathcal{E} = - N \frac{d \Phi_B}{d t} \quad \text{coil of } N \text{ turn}$$

- The general means by which we can change the magnetic flux through a coil:
 1. Change the magnitude B of the magnetic field within the coil.
 2. Change either the total area of the coil or the portion of that area that lies within the magnetic field.
 3. Change the angle between the direction of the magnetic field and the plane.

Lenz's Law

● **Lenz's law** for determining the direction of an induced current in a loop:

An induced current has a direction such that the magnetic field due to the current opposes the change in the magnetic flux that induces the current.

● The direction of an induced emf is that of \mathcal{E}

● 2 different but equivalent ways:

1. Opposition to Pole Movement.

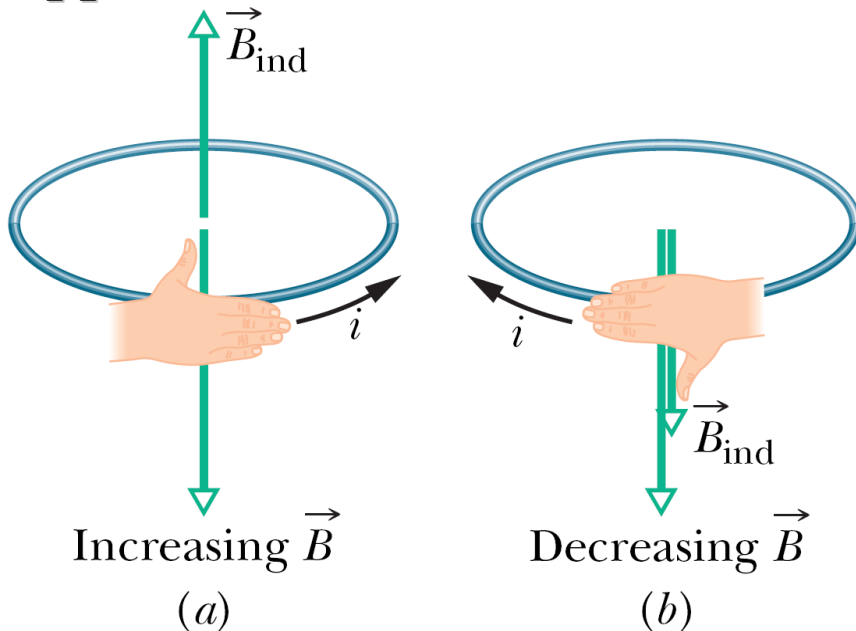

2. Opposition to Flux Change.

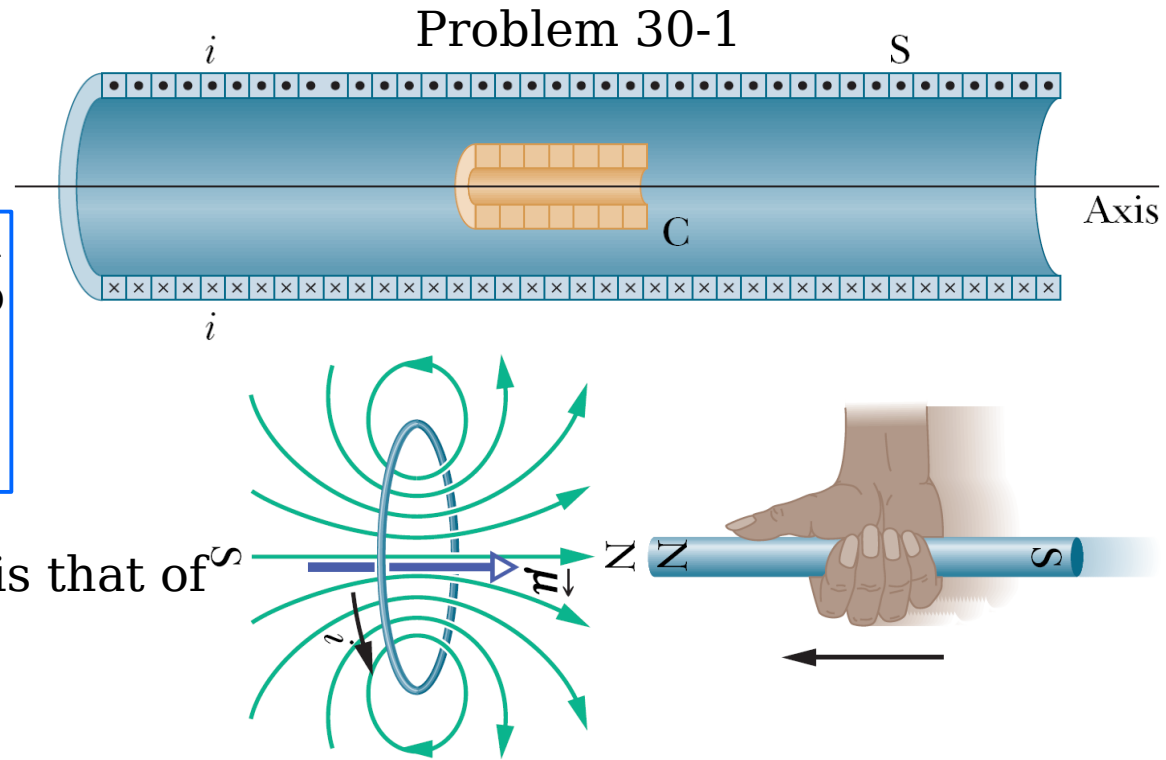
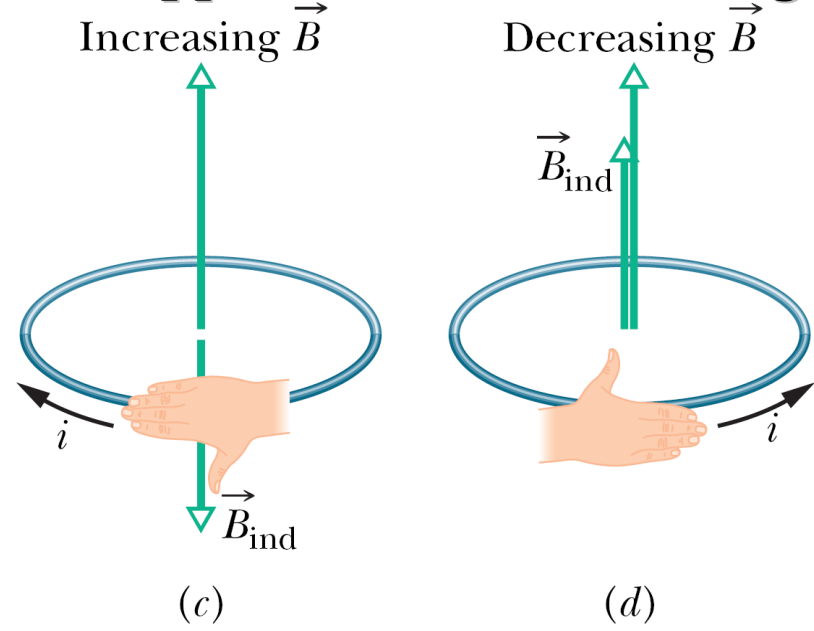

- The flux of \vec{B}_i always opposes the change in the flux of \vec{B} , but that does not always mean that \vec{B}_i points opposite \vec{B} .

Electric Guitars

- In an electric guitar, the oscillations of the metal strings are sensed by electric “pickups” that send signals to an amplifier and a set of speakers.

- When the string is plucked and thus made to oscillate, its motion relative to the coil changes the flux of its magnetic field through the coil, inducing a current in the coil. As the string oscillates toward and away from the coil, the induced current changes direction at the same frequency as the string's oscillations, thus relaying the frequency of oscillation to the amplifier and speaker.

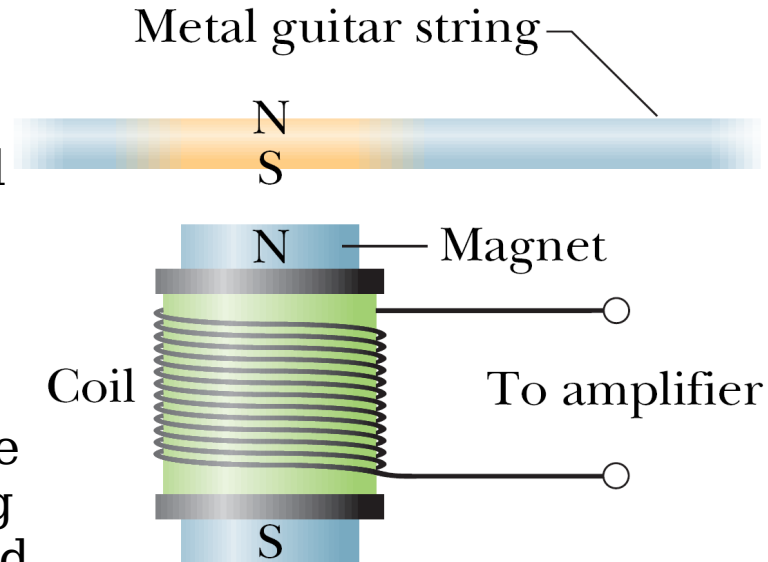

problem 30 -2

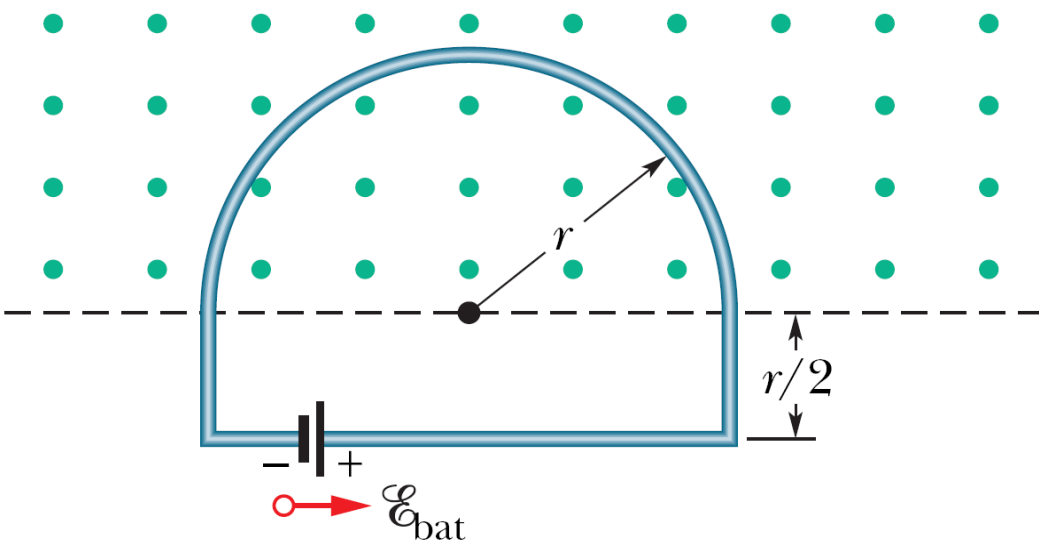

problem 30-3

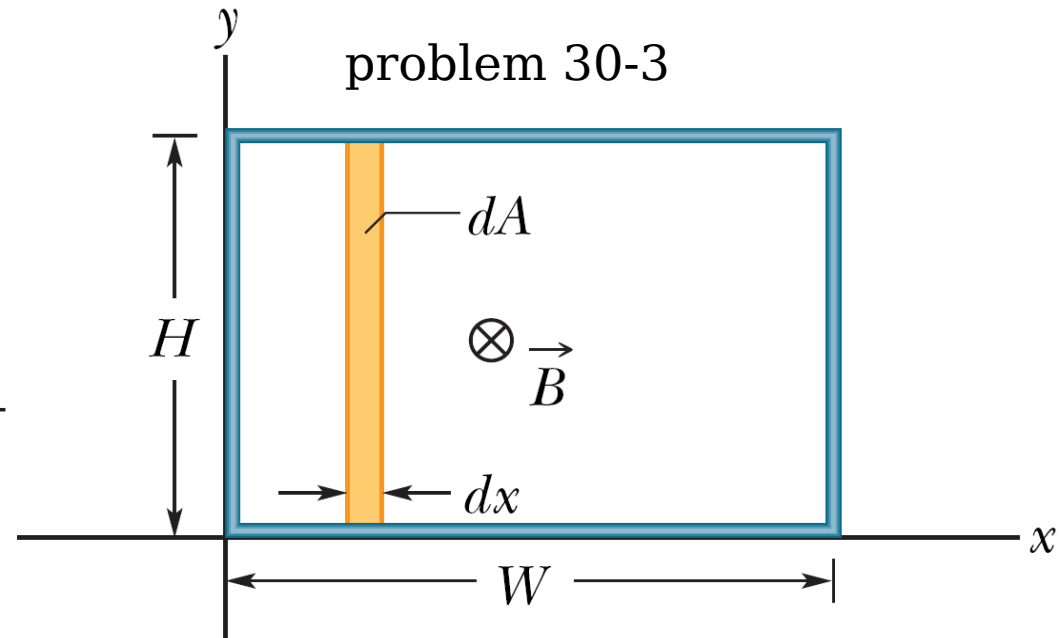

Induction and Energy Transfers

- By Lenz's law, whether you move the magnet toward or away from a loop, a magnetic force resists the motion, requiring your applied force to do positive work.

- At the same time, thermal energy is produced in the material of the loop because of the material's electrical resistance to the current that is induced by the motion.

- The energy you transfer to the closed loop magnet system via your applied force ends up in this thermal energy.

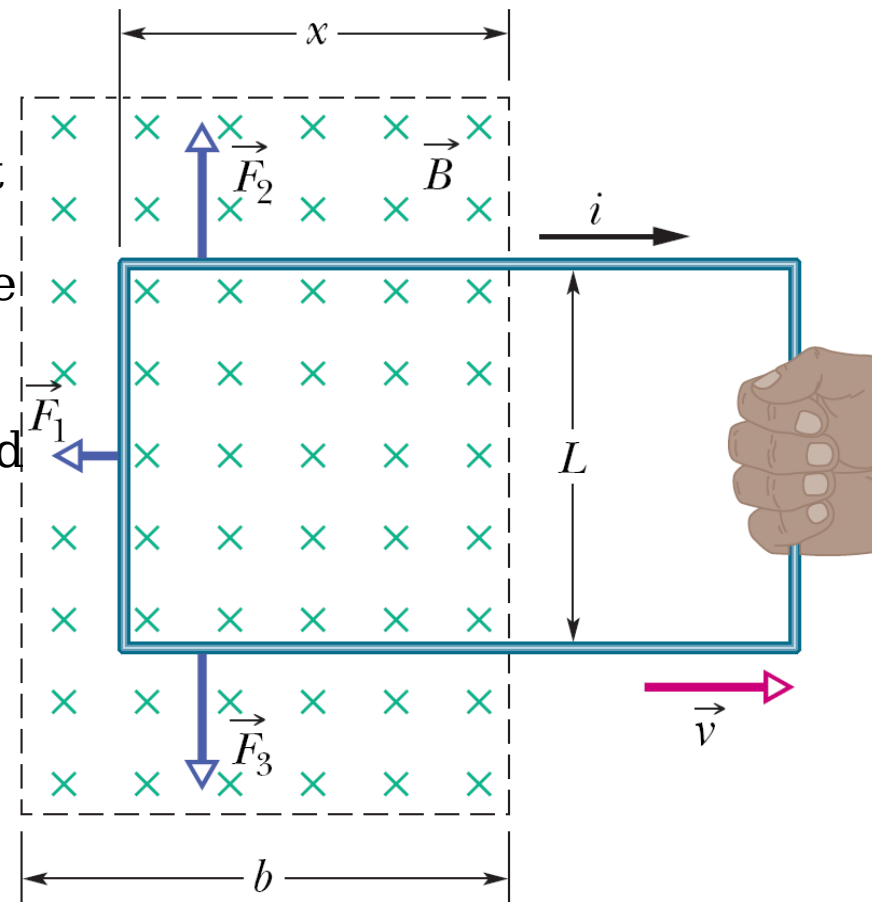

- The rate at which you do work – that is, the power – is then $P = F v$

- The magnitude of the flux through the loop: $\Phi_B = B A = B L x$

- The magnitude of this emf is

$$|\mathcal{E}| = \frac{d \Phi_B}{d t} = \frac{d}{d t} B L x = B L \frac{d x}{d t} = B L v$$

- The direction of the induced current i is obtained with a right-hand rule for decreasing flux; applying the rule tells us that the current must be clockwise, and \mathcal{E} must have the same direction.

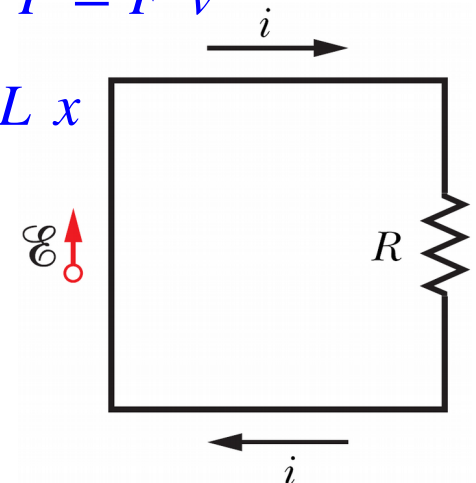

- To find the magnitude of the induced current, apply the equation $i = \mathcal{E}/R$, then

$$i = \frac{B L v}{R}$$

- Because 3 segments of the loop carry this current through the magnetic field, sideways deflecting forces act on those segments,

$$\vec{F}_d = i \vec{L} \times \vec{B}$$

- From the symmetry, forces \vec{F}_2 and \vec{F}_3 are equal in magnitude and cancel. \vec{F}_1 is directed opposite your force \vec{F} on the loop and thus

$$\vec{F}_1 = -\vec{F}$$

- Then we have $F \equiv |\vec{F}| = |\vec{F}_1| = F_1 = i L B \sin \frac{\pi}{2} = i L B = \frac{B^2 L^2 v}{R}$

- The speed v at which you move the loop is constant if the magnitude F of the force you apply to the loop is also constant.

- The rate at which you do work on the loop as you pull it from the magnetic field:

$$P = F v = \frac{B^2 L^2 v^2}{R} \quad \text{rate of doing work}$$

- The rate at which thermal energy appears in the loop as you pull it along at constant speed:

$$P = i^2 R = \left(\frac{B L v}{R} \right)^2 R = \frac{B^2 L^2 v^2}{R} \quad \text{thermal energy rate}$$

- The work that you do in pulling the loop through the magnetic field appears as thermal energy in the loop.

Burns During MRI Scans

- A patient undergoing an MRI scan lies in an apparatus containing 2 magnetic fields: a large constant field and a small sinusoidally varying field.

- The cable and the lower part of the arm then formed a closed loop through which the varying magnetic field produced a varying flux, and thus an induced emf and an induced current.

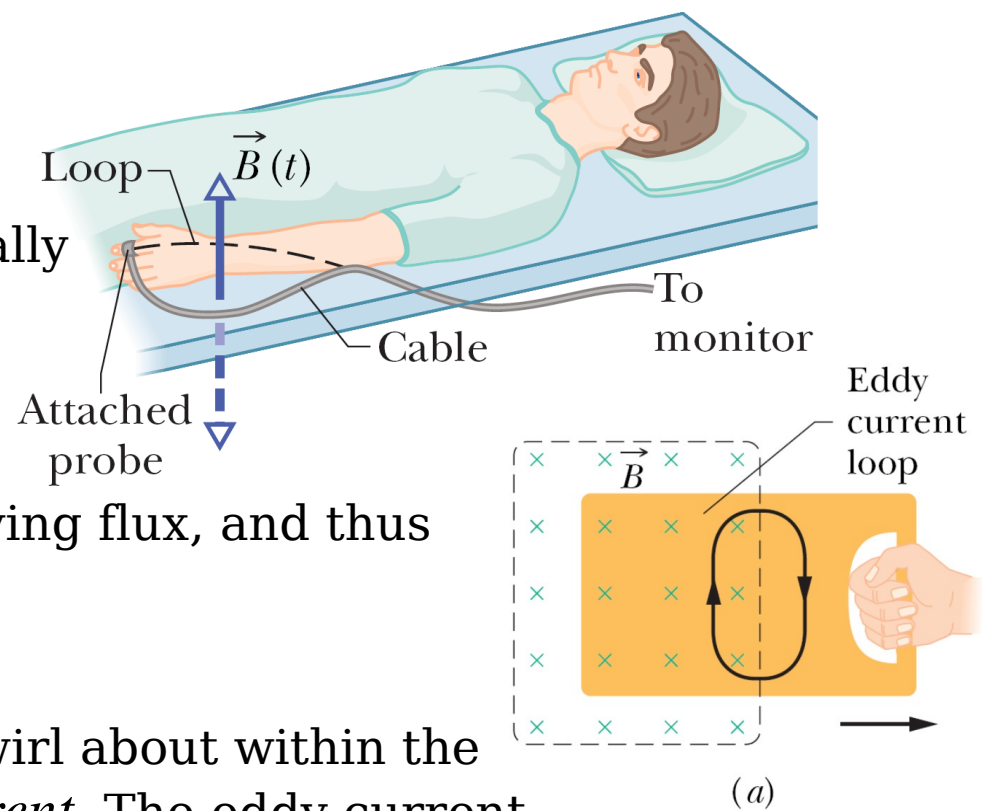

Eddy Currents

- With a plate, the conduction electrons swirl about within the plate. Such a current is called an *eddy current*. The eddy current induced in the plate results in mechanical energy being dissipated as thermal energy.

- Induction furnace: the changing creates eddy currents within the metal, increases the temperature of the metal to the melting point.

Induced Electric Fields

- If there is an induced current in the copper ring, an electric field must be present along the ring because an electric field is needed to do the work of moving the conduction electrons.

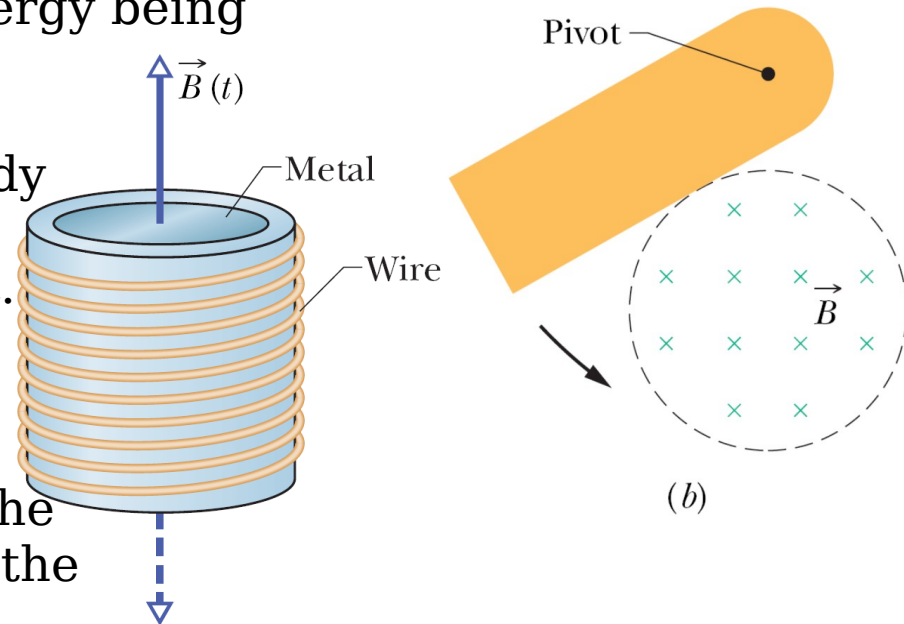

- The electric field must have been produced by the changing magnetic flux.
- Restatement of Faraday's law of induction:

A changing magnetic field produces an electric field.

- Thus the electric field is induced even if there is no conducting wire.

A Reformulation of Faraday's Law

- The work W done on a charged particle in one revolution by the induced electric field is $W = \mathcal{E}q_0$, where \mathcal{E} is defined as the work done per unit charge in moving the test charge around the path.

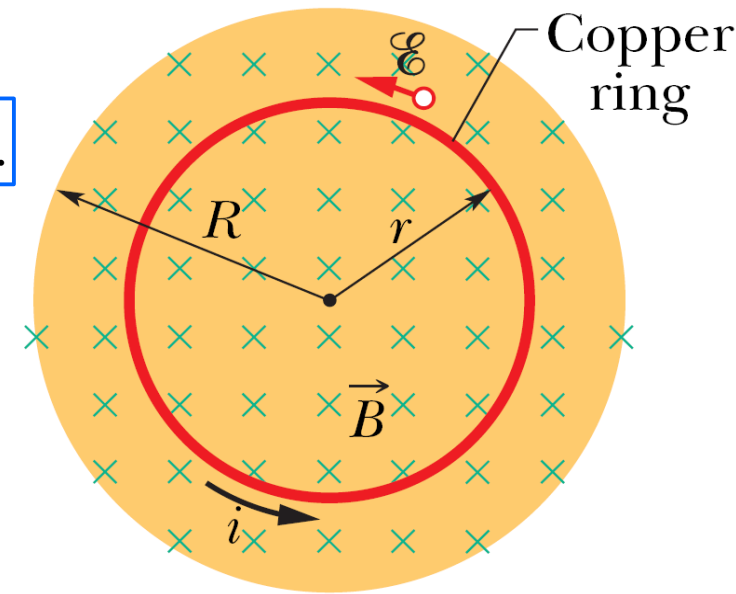

(a)

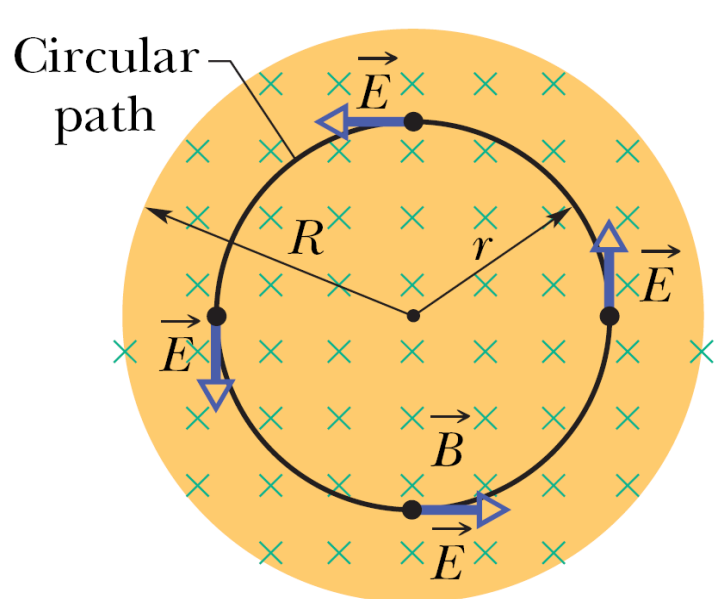

(b)

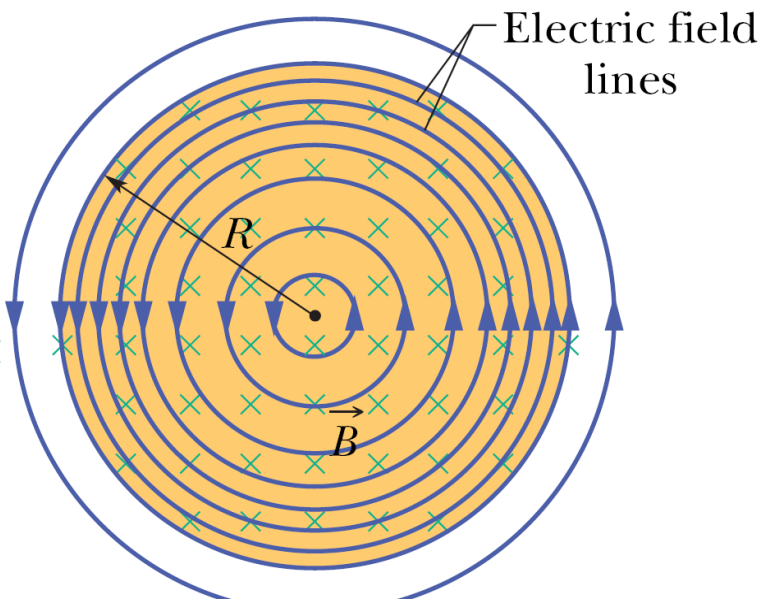

(c)

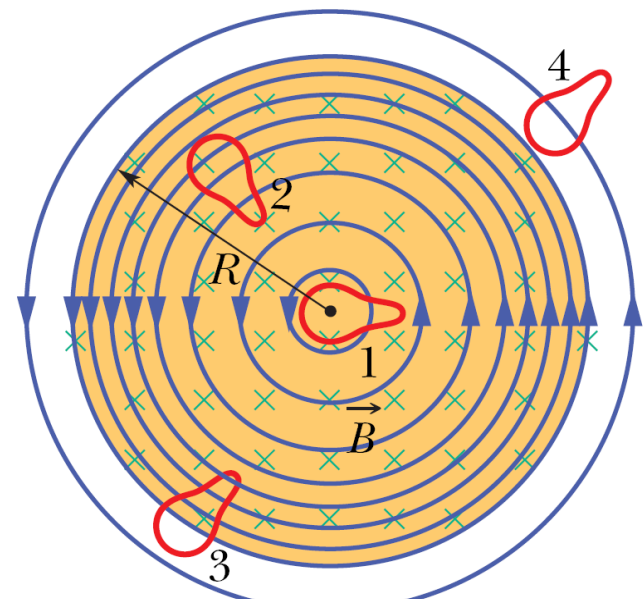

(d)

- From another point of view, the work is $W = \int \vec{F} \cdot d\vec{s} = (q_0 E) (2 \pi r)$
- Setting these 2 expressions for W equal to each other: $\mathcal{E} = 2 \pi r E$
- To give a more general expression for the work done on a charged particle moving along any closed path

$$W = \oint \vec{F} \cdot d\vec{s} = q_0 \oint \vec{E} \cdot d\vec{s} \Rightarrow \mathcal{E} = \oint \vec{E} \cdot d\vec{s}$$
- An induced emf can be explained as the sum – via integration – of quantities $\vec{E} \cdot d\vec{s}$ around a closed path, doesn't need a current or particle.
- Combine the above equation with Faraday's law($\mathcal{E} = -d\Phi_B/dt$) to rewrite the Faraday's law as

$$\oint \vec{E} \cdot d\vec{s} = - \frac{d\Phi_B}{dt} \quad \text{Faraday's law}$$
- A changing magnetic field induces an electric field.

A New Look at Electric Potential

- The difference between electric fields produced by induction and those produced by static charges

Electric potential has meaning only for electric fields that are produced by static charges; it has no meaning for electric fields that are produced by induction.

- It is because the definition of potential is $V_f - V_i = - \int_i^f \vec{E} \cdot d\vec{s}$
 In a closed loop, the expression should vanish $\oint \vec{E} \cdot d\vec{s} = 0$

● When a changing magnetic flux is present, this integral is *not* 0 but is $-d\Phi_B/dt$. Thus, assigning electric potential to an induced electric field leads us to a contradiction.

problem 30-4

Inductors and Inductance

● An **inductor** (symbol ) can be used to produce a desired magnetic field. We shall consider a long solenoid as our basic type of inductor.

● The **inductance** of the inductor is

$$L = \frac{N \Phi_B}{i} \quad \text{inductance defined}$$

● The windings of the inductor are said to be *linked* by the shared flux, and the product $N\Phi_B$ is called the *magnetic flux linkage*. r (cm)

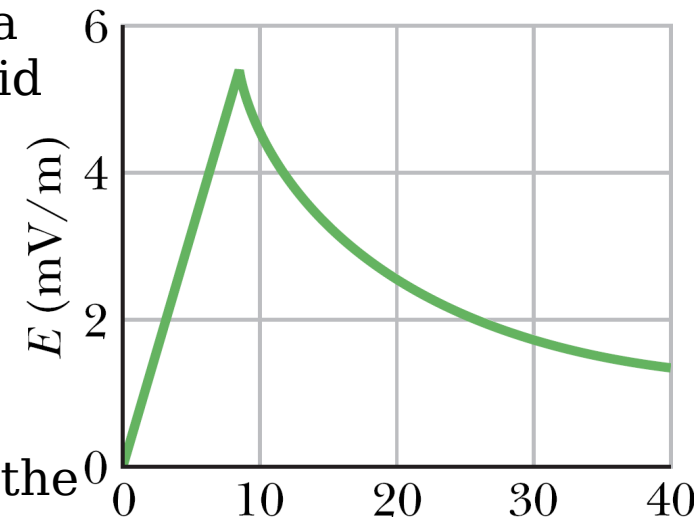

● The inductance L is thus a measure of the flux linkage produced by the inductor per unit of current.

● The SI unit of inductance is the tesla-square meter per ampere ($T \cdot m^2/A$), or **henry** (H),
 $1 \text{ henry} = 1 \text{ H} = 1 \text{ T} \cdot m^2 / A$

Inductance of a Solenoid

● The flux linkage for the cross-section of a solenoid is $N \Phi_B = (n \ell) (B A)$

● Since the magnitude of the magnetic field is

$$B = \mu_0 i n \Rightarrow L = \frac{N \Phi_B}{i} = \frac{(n \ell) (B A)}{i} = \frac{(n \ell) (\mu_0 i n) (A)}{i} = \mu_0 n^2 \ell A$$

and the inductance per unit length near the center of a long solenoid is

$$\frac{L}{\ell} = \mu_0 n^2 A \quad \text{solenoid}$$

● Inductance – like capacitance – depends only on the geometry of the device.

● Since n is a number per unit length, an inductance can be written as a product of the permeability constant μ_0 and a quantity with the dimensions of a length.

This means that μ_0 can be expressed in the unit henry per meter:

$$\mu_0 = 4 \pi \times 10^{-7} \text{ T} \cdot \text{m} / \text{A} = 4 \pi \times 10^{-7} \text{ H} / \text{m}$$

Self-Induction

An induced emf \mathcal{E}_L appears in any coil in which the current is changing.

● This process is called **self-induction**, and the emf that appears is called a **self-induced emf**.

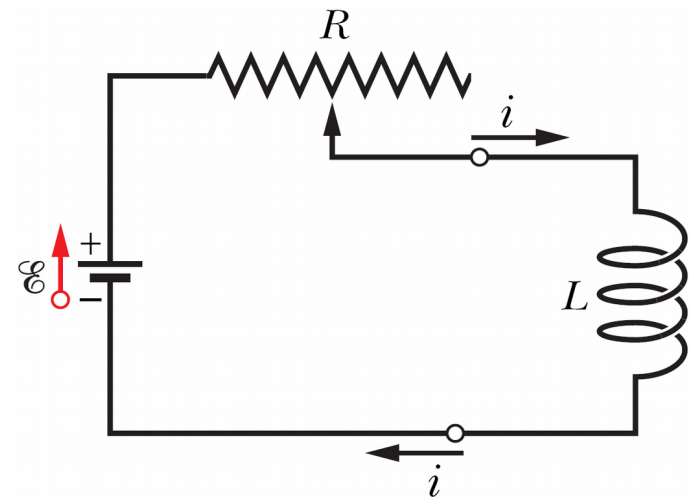

- From the definition of inductance and Faraday's law,

$$N \Phi_B = L i \quad \text{and} \quad \mathcal{E}_L = - \frac{d(N \Phi_B)}{d t}$$

$$\Rightarrow \mathcal{E}_L = - L \frac{d i}{d t} \quad \text{self-induced emf}$$

- In any inductor, a self-induced emf appears whenever the current changes with time. The magnitude of the current has no influence on the magnitude of the induced emf; only the rate of change of the current counts.

- We can find the *direction* of a self-induced emf from Lenz's law: the self-induced emf \mathcal{E}_L has the orientation such that it opposes the change in current.

- When a self-induced emf is produced in an inductor, we cannot define an electric potential within the inductor itself, where flux is changing. However, potential can still be defined at points of the circuit not within the inductor.

- We can define a self-induced potential difference V_L across an inductor. For an ideal inductor, the magnitude of V_L is equal to the magnitude of the self-induced emf \mathcal{E}_L .

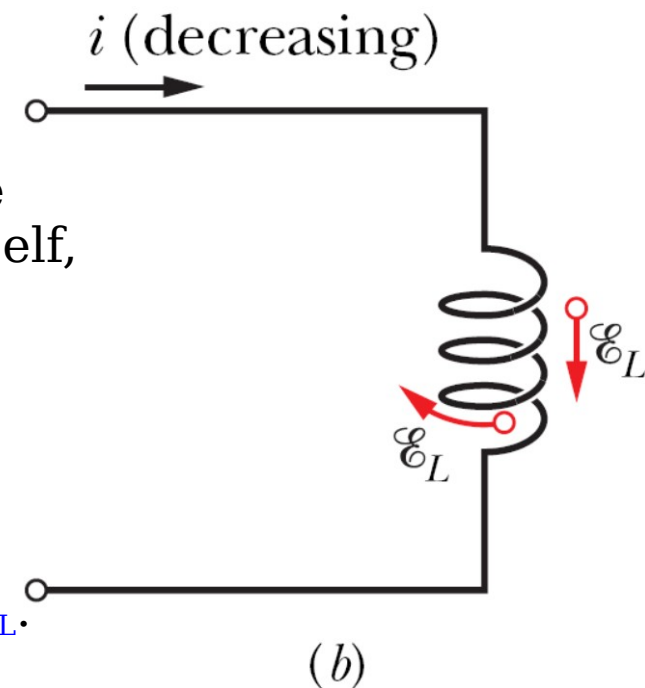
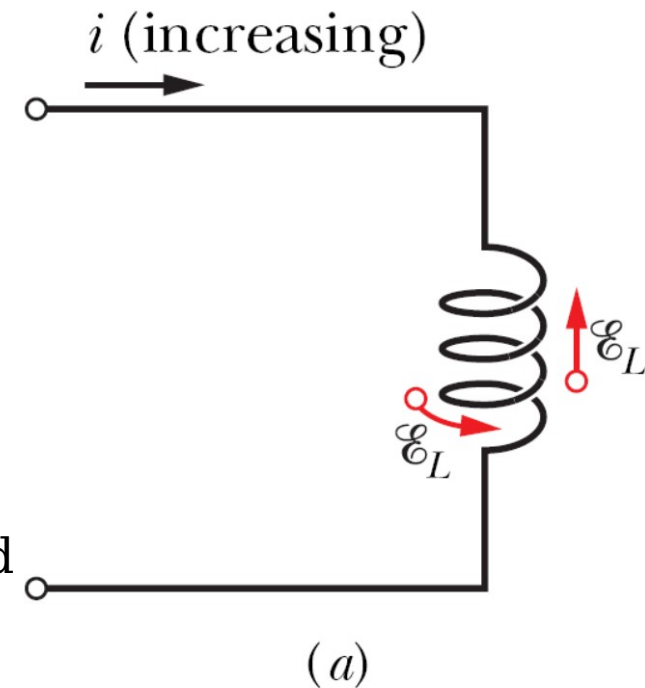

- If the wire in the inductor has resistance r , we mentally separate the inductor into a resistance r and an ideal inductor of self-induced emf \mathcal{E}_L .

RL Circuits

- If we introduce an emf \mathcal{E} into a single-loop RC circuit, the charge on the capacitor is:

$$q = C \mathcal{E} \left(1 - e^{-\frac{t}{\tau_c}} \right)$$

- The rate at which the charge builds up is determined by the capacitive time constant $\tau_c = RC$.

- If we suddenly remove the emf from this same circuit, then $q = q_0 e^{-\frac{t}{\tau_c}}$

- An analogous slowing of the rise (or fall) of the current occurs if we introduce an emf \mathcal{E} into (or remove it from) a single-loop circuit containing a

resistor R and an inductor L .

Initially, an inductor acts to oppose changes in the current through it. A long time later, it acts like ordinary connecting wire.

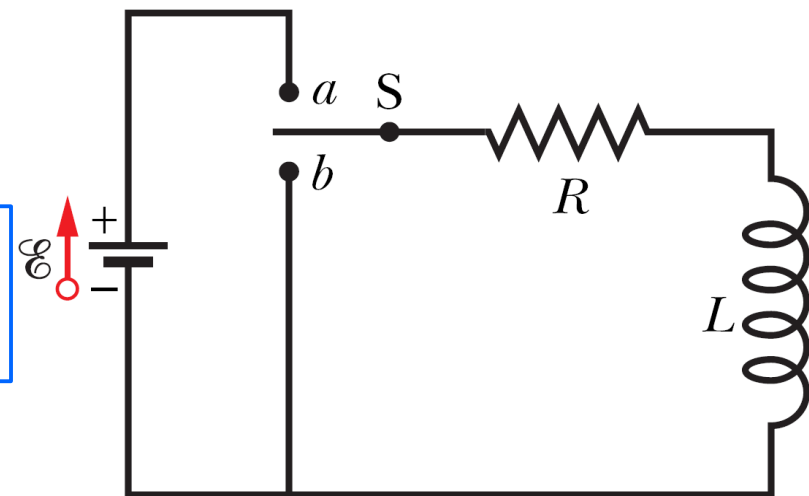

- Let us apply the loop rule, then

1. the resistor gives $-iR$,
2. the inductor gives $\mathcal{E}_L = -L \frac{di}{dt}$
3. the battery gives the potential change $+\mathcal{E}$.

- The loop rule gives us

$$-iR - L \frac{di}{dt} + \mathcal{E} = 0 \Rightarrow L \frac{di}{dt} + Ri = \mathcal{E} \quad \text{RL circuit}$$

- Similar to a RC circuit, the solution $i = \frac{\mathcal{E}}{R} \left(1 - e^{-\frac{Rt}{L}} \right)$

here we can rewrite $i = \frac{\mathcal{E}}{R} \left(1 - e^{-\frac{t}{\tau_L}} \right)$ rise of current

- The inductive time constant τ_L is $\tau_L = \frac{L}{R}$ time constant

- The current $i = 0$ at $t = 0$. If t go to ∞ , then the current goes to its equilibrium value of \mathcal{E}/R .

- To show that the quantity $\tau_L (=L/R)$ has the dimension of time,

$$1 \frac{\text{H}}{\Omega} = 1 \frac{\text{V} \cdot \text{s}/\text{A}}{\text{V}/\text{A}} = 1 \text{ s}$$

- If we put $t = \tau_L = L/R$, then $i = \frac{\mathcal{E}}{R} (1 - e^{-1}) = 0.63 \frac{\mathcal{E}}{R}$

- Thus, the time constant τ_L is the time it takes the current in the circuit to reach about 63% of its final equilibrium value \mathcal{E}/R .

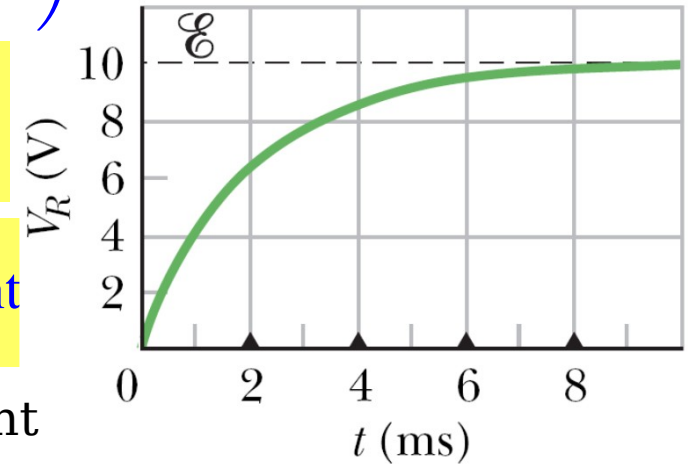
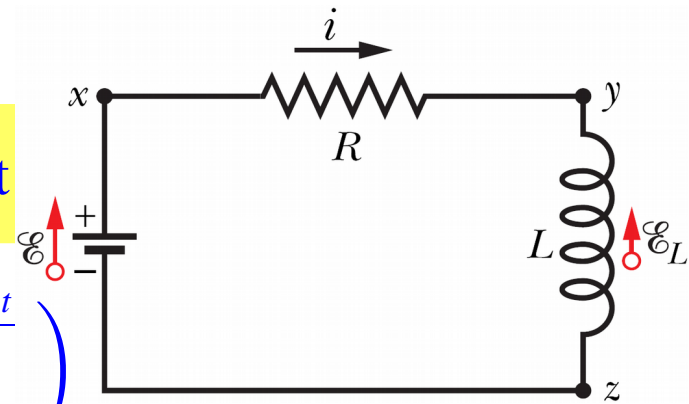

(a)

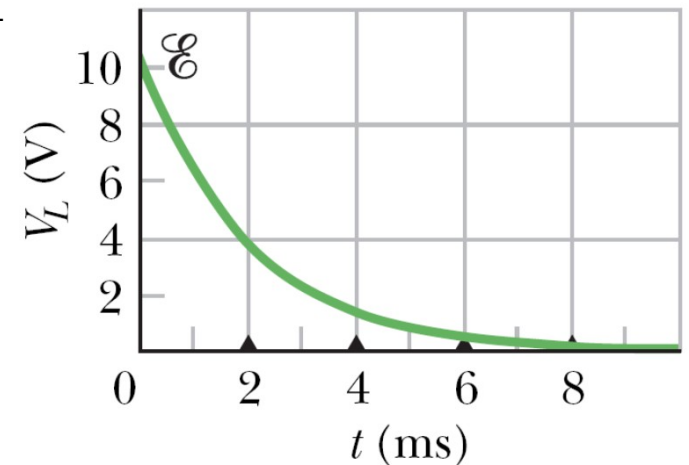

(b)

- The differential equation that governs the decay is $L \frac{d i}{d t} + R i = 0$

- The solution of this differential equation that satisfies the initial condition $i(0) = i_0$ is

$$i = i_0 e^{-\frac{t}{\tau_L}} \quad \text{decay of current}$$

problem 30-5

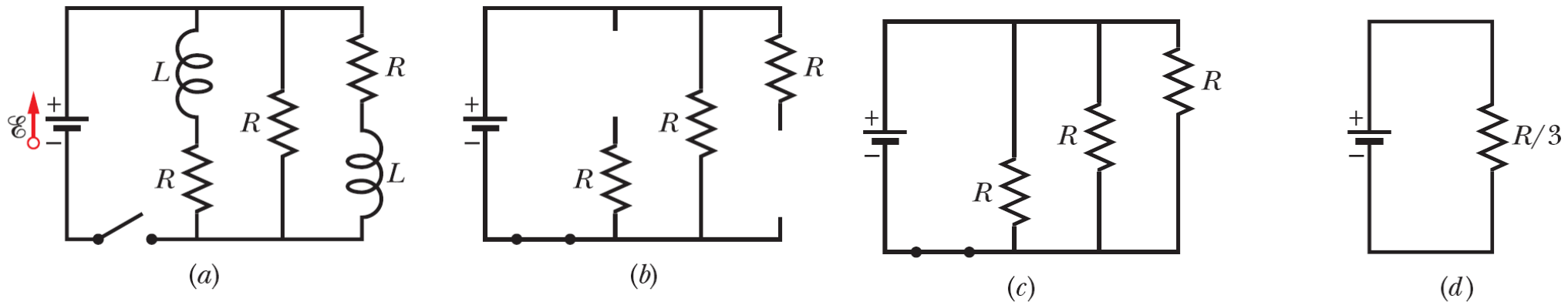

problem 30-6

Energy Stored in a Magnetic Field

- In a RL circuit, $\mathcal{E} = L \frac{d i}{d t} + R i$

- If we multiply each side by i , we obtain $\mathcal{E} i = L i \frac{d i}{d t} + i^2 R$

which has the following physical interpretation in terms of work and energy:

1. The rate at which the battery does work is $\mathcal{E} dq/dt$, or $\mathcal{E} i$. Thus, the left side represents the rate at which the emf device delivers energy to the rest of the circuit.

2. The rightmost term represents the rate at which energy appears as thermal energy in the resistor.
3. Energy that is delivered to the circuit but does not appear as thermal energy must, by the conservation-of-energy hypothesis, be stored in the magnetic field of the inductor. Thus the middle term must represent the rate dU_B / dt at which magnetic potential energy U_B is stored in the magnetic field.

● Thus,
$$\frac{d U_B}{d t} = L i \frac{d i}{d t} \Rightarrow d U_B = L i d i \Rightarrow \int_0^{U_B} d U_B = \int_0^i L i d i$$

$\Rightarrow U_B = \frac{1}{2} L i^2$ magnetic energy

which represents the total energy stored by an inductor L carrying a current i .

- Note the similarity in form between this expression and the expression for the energy stored by a capacitor with capacitance C and charge q ;

$$U_E = \frac{q^2}{2 C}$$

problem 30-7

Energy Density of a Magnetic Field

- Consider a length ℓ near the middle of a long solenoid of cross-sectional area A carrying current i ; the volume associated with this length is $A\ell$. Thus, the energy stored per unit volume of the field is

$$u_B = \frac{U_B}{A\ell} = \frac{L i^2}{2 A \ell} = \frac{L}{\ell} \frac{i^2}{2 A} \quad \Leftarrow \quad U_B = \frac{1}{2} L i^2 \quad \& \quad \frac{L}{\ell} = \mu_0 n^2 A \quad \Rightarrow \quad u_B = \frac{1}{2} \mu_0 n^2 i^2$$

Since $B = \mu_0 n i$ then the *energy density* $u_B = \frac{B^2}{2 \mu_0}$ magnetic energy density

- This energy density expression holds for all magnetic fields, no matter how they are generated.
- The equation is comparable to the energy density expression for electric field:

$$u_E = \frac{1}{2} \epsilon_0 E^2$$

- Note that both u_B and u_E are proportional to the square of the appropriate field magnitude, B or E .

Mutual Induction

● If we change i with time in Coil 1, an emf appears in Coil 2; we called this process **mutual induction**.

● Define the mutual inductance M_{21} of coil 2 with respect to coil 1 as

$$M_{21} = \frac{N_2 \Phi_{21}}{i_1} \Rightarrow M_{21} i_1 = N_2 \Phi_{21}$$

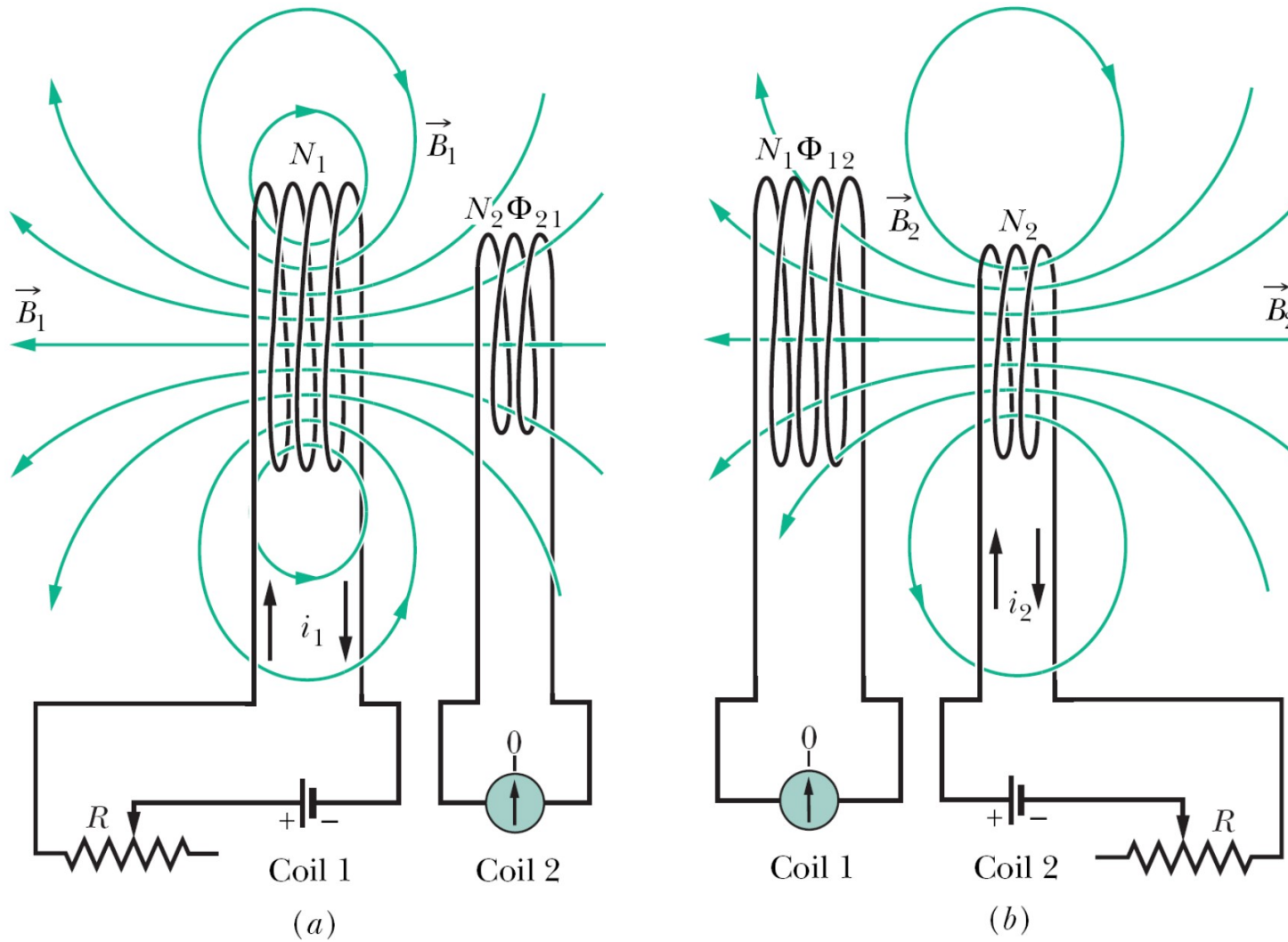

- If we vary i_1 , then $M_{21} \frac{d i_1}{d t} = N_2 \frac{d \Phi_{21}}{d t}$

- The right side of this equation is the magnitude of the emf \mathcal{E}_2 appearing in coil 2 due to the changing current in coil 1. Thus, with a minus sign to indicate direction,

$$\mathcal{E}_2 = - M_{21} \frac{d i_1}{d t}$$

- Let us now interchange the roles of coils 1 and 2, then $\mathcal{E}_1 = - M_{12} \frac{d i_2}{d t}$

- The emf induced in either coil is proportional to the rate of change of current in the other coil.

- Assert, without proof, $M_{12} = M_{21} = M$, then

$$\mathcal{E}_2 = - M \frac{d i_1}{d t}, \quad \mathcal{E}_1 = - M \frac{d i_2}{d t}$$

Selected problems: 14, 26, 40, 58, 76

Problem 30-8

